

AEG



aeg.com/register



NCH74B01AB

INSTALLATION

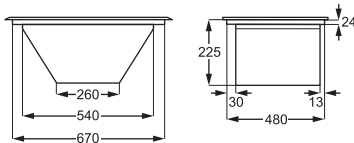
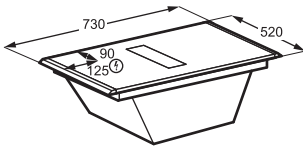
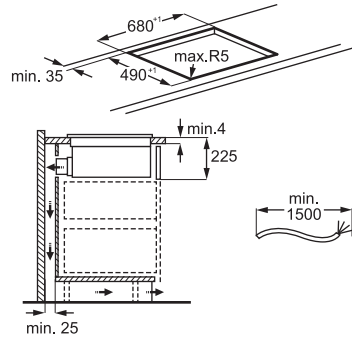
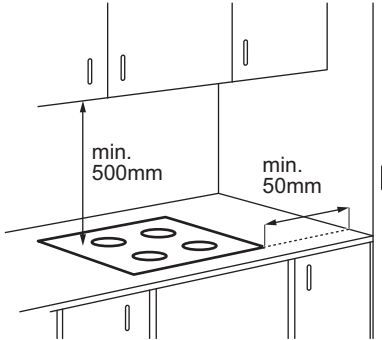

www.youtube.com/electrolux
www.youtube.com/aeg

How to Install your
 AEG/Electrolux Extractor Hob



1. SAFETY INFORMATION.....	2	7. COOKING GUIDE.....	12
2. SAFETY INSTRUCTIONS.....	5	8. CARE AND CLEANING.....	12
3. ASSEMBLY.....	7	9. TROUBLESHOOTING.....	14
4. PRODUCT DESCRIPTION.....	8	10. TECHNICAL DATA.....	14
5. BEFORE FIRST USE.....	9	11. ENERGY EFFICIENCY.....	15
6. DAILY USE.....	9	12. ENVIRONMENTAL CONCERNS.....	16

1. ⚠ SAFETY INFORMATION

Before the installation and use of the appliance read the supplied instructions carefully.

The manufacturer is not responsible for any injuries or damage that result from in-

correct installation or usage. Always keep the instructions in a safe and accessible location for future reference.

1.1 Children and vulnerable people safety

- This appliance can be used by children aged from 8 years and above and persons with reduced physical, sensory or mental capabilities or lack of experience and knowledge if they have been given supervision or instruction concerning the use of the appliance in a safe way and understand the hazards involved. Children of less than 8 years of age and persons with very extensive and complex disabilities shall be kept away from the appliance unless continuously supervised.
- Children should be supervised to ensure that they do not play with the appliance.
- Keep packaging away from children and dispose of it properly.
- **WARNING:** The appliance and its accessible parts become hot during use. Keep children and pets away during use and cooling.
- Activate the child safety device, if available.

- Children must not clean or maintain the appliance without supervision.

1.2 General Safety

- This appliance is for cooking purposes only.
- This appliance is designed for single household domestic use in an indoor environment.
- This appliance may be used in offices, hotel guest rooms, bed & breakfast guest rooms, farm guest houses, and other similar accommodation where such use does not exceed average domestic usage levels.
- **WARNING:** Danger of fire: Do not store items on the cooking surfaces.
- **CAUTION:** The cooking process has to be supervised. A short term cooking process has to be supervised continuously.
- **WARNING:** Unattended cooking on a hob with fat or oil can be dangerous and may result in a fire.
- **WARNING:** The appliance and its accessible parts become hot during use. Care should be taken to avoid touching the heating elements.

- Smoke indicates overheating. Never use water to extinguish the cooking fire. Switch off the appliance and cover flames with e.g. a fire blanket or a lid.
 - **WARNING:** The appliance must not be supplied through an external switching device, such as a timer, or connected to a circuit that is regularly switched on and off by a utility.
 - Metallic objects such as knives, forks, spoons and lids should not be placed on the hob surface since they can get hot.
 - Do not use the appliance before installing it in the built-in structure.
 - Do not use water spray and steam to clean the appliance.
 - After use, switch off the hob element by its control and do not rely on the pan detector.
 - **WARNING:** If the surface is cracked, switch off the appliance to avoid the possibility of electric shock. In case the appliance is connected to the mains directly using junction box, remove the fuse to disconnect the appliance from power supply. In either case contact
- the Authorised Service Centre.
 - Ensure good air ventilation in the room where the appliance is installed to avoid the backflow of gases into the room from appliances burning gas or other fuels, including open fires.
 - Make sure that the ventilation openings are not blocked and the air collected by the appliance is not conveyed into a duct used to exhaust smoke and steam from other appliances (central heating systems, thermosiphons, water-heaters, etc.).
 - Failure to comply may lead to the backflow of combustion gases, causing risk of carbon monoxide poisoning or suffocation.
 - When the appliance operates with other appliances the maximum vacuum generated in the room should not exceed 0.04 mbar.
 - Clean the extractor filter and remove grease deposits regularly to prevent the risk of fire.
 - If the supply cord is damaged, it must be replaced by the manufacturer, its Authorised Service Centre or similarly qualified persons

to avoid an electrical hazard.

- If the appliance is connected directly to the power supply, the electrical installation must be equipped with an isolating device that allows to disconnect the appliance from the mains at all poles. Complete disconnection must comply with conditions specified in the overvoltage category III. The means for disconnection must be incorporated in

the fixed wiring in accordance with the wiring rules.

- **WARNING:** Use only hob guards designed by the manufacturer of the cooking appliance, or those indicated by the manufacturer of the appliance in the instructions for use as suitable, or hob guards that are incorporated in the appliance. The use of inappropriate guards can cause accidents.

2. SAFETY INSTRUCTIONS

2.1 Installation

WARNING!

Only a qualified technician must install this appliance.

WARNING!

Risk of injury or damage to the appliance.

- Remove all the packaging.
- Do not install or use a damaged appliance.
- Refer to the installation booklet for detailed assembly instructions.
- Keep the minimum distance from other appliances and units.
- Be careful when moving the appliance, as it is heavy. Use safety gloves and enclosed footwear.
- Seal the cut surfaces of the cabinet with a sealant to prevent moisture swelling.
- Protect the bottom of the appliance from steam and moisture.
- Do not install the appliance next to a door or under a window to prevent hot cookware from falling from the appliance when the door or the window is opened.
- Do not install in a manner that exhausts air into a wall cavity, unless the cavity is designed for that purpose.

- For ductless installation, the fan outlet must be positioned directly against the wall or must be separated by an additional cabinet wall, in order to prevent access to the fan blades.
- Each appliance has cooling fans on the bottom.
- If the appliance is installed above a drawer:
 - Do not store small items or paper that could damage the cooling fans or impair the cooling system.
 - Keep a minimum 2 cm distance between the appliance bottom and drawer contents.
- Remove any separator panels installed in the cabinet below the appliance.

2.2 Electrical Connection

WARNING!

Risk of fire and electric shock.

- All electrical connections should be made by a qualified electrician according to the connection diagram or installation booklet.
- In the case of exhaust installation, and where the accessories are present or mandatory (wall valve, window switch and/or window opener) electrical connections should be made by a qualified

- electrician, according to the connection diagram or installation booklet.
- The appliance must be earthed.
 - Disconnect the appliance from the power supply before any operation.
 - Make sure that the parameters on the rating plate are compatible with the electrical ratings of the mains power supply.
 - Loose or incorrect mains cables or plugs may lead to overheating of the terminal.
 - Use the correct mains cable.
 - Do not let the mains cable tangle.
 - Ensure shock protection is installed.
 - Use the strain relief clamp on the mains cable.
 - Ensure the mains cable or plug (if applicable) do not touch hot surfaces.
 - Do not use multi-plug adapters and extension cables.
 - Avoid damaging the mains plug and cable. If replacement is needed, it must be done by our Authorised Service Centre or a qualified electrician.
 - Shock protection of live and insulated parts must be fastened securely and should not be removable without tools.
 - Connect the mains plug to the socket only at the end of installation. Ensure access to the mains plug after installation.
 - If the mains socket is loose, do not connect the mains plug.
 - Do not disconnect the appliance by pulling on the mains cable. Always pull on the mains plug.
 - Use only correct isolation devices: line protecting cut-outs, fuses (screw type fuses removed from the holder), earth leakage trips and contactors.
 - The electrical installation must have an isolation device that disconnects the appliance from the mains at all poles, with a contact opening width of at least 3 mm.

2.3 Use

WARNING!

Risk of injury, burns and electric shock.

- Do not change the specification of the appliance.
- Remove all the packaging, labelling and protective film (if applicable) before first use.
- Ensure ventilation openings are not blocked. The ventilation must be checked periodically by a qualified technician.
- Do not leave the appliance unattended during operation.

- Turn off the cooking zone after each use.
- Do not place cutlery or saucepan lids on cooking zones, as they can become hot.
- Do not operate the appliance with wet hands or when it comes in contact with water.
- Do not use the appliance as a work surface or as a storage surface.
- If the surface of the appliance is cracked, immediately disconnect the appliance from the power supply to prevent the electric shock.
- Users with a pacemaker must keep a distance of minimum 30 cm from the induction cooking zones when the appliance is in use.
- Place food into hot oil carefully as it may splash.
- Never use an open flame when the extractor operates.
- Do not use aluminum foil or other materials between the cooking surface and the cookware, unless otherwise specified by the manufacturer of this appliance.
- Use only accessories recommended for this appliance by the manufacturer.

WARNING!

Risk of fire and explosion.

- Heated fats and oils can release flammable vapors. Keep flames and heated objects away.
- Hot oil vapors can cause spontaneous combustion.
- Used oil with food remnants can ignite at lower temperatures.
- Do not place flammable products near the appliance.

WARNING!

Risk of damage to the appliance.

- Do not place hot cookware on the control panel to avoid the risk of burns.
- Do not put a hot pan cover on the glass surface of the appliance.
- Do not let cookware boil dry.
- Prevent objects or cookware from falling onto the appliance to avoid the surface damage.
- Do not activate the cooking zones with empty cookware or without cookware.
- Never remove the grid or the filter while the extractor or the hob operates.
- Never use an open flame while the extractor operates.

- Do not cover the inlet of the extractor with cookware.
- Do not access the underside of the appliance while the hob or the extractor operates.
- Do not place small or light objects near the extractor to avoid the risk of being trapped.
- Cookware made of cast iron or with a damaged bottom can cause scratches on the glass / glass ceramic. Always lift cookware up when you have to move it on the cooking surface.
- Concerning the lamp(s) inside this product and spare part lamps sold separately: These lamps are intended to withstand extreme physical conditions in household appliances, such as temperature, vibration, humidity, or are intended to signal information about the operational status of the appliance. They are not intended to be used in other applications and are not suitable for household room illumination.
- To repair the appliance contact the Authorised Service Centre. Use original spare parts only.

2.4 Care and cleaning

- Clean the appliance regularly to prevent surface deterioration.
- Switch off the appliance and let it cool down before cleaning.
- Clean the appliance with warm water and a moist soft cloth. Use only neutral detergents. Do not use abrasive products, abrasive cleaning pads, solvents or metal objects, unless otherwise specified.

2.5 Disposal

WARNING!

Risk of injury or suffocation.

- Contact your local authority for information on how to dispose of the appliance.
- Disconnect the appliance from the mains supply, then cut off and dispose of the electrical cable.

3. ASSEMBLY

3.1 Before the installation

For future reference, find the rating plate located on the bottom of the hob and write down the serial number

3.2 Assembling the hob

 For installation dimensions and visual guidance, refer to the installation diagrams located on the first pages of the user manual.

Refer to the installation booklet for detailed information on how to assemble your hob.

Follow the hob connection diagram and the window switch connection diagram (if applicable) presented in the installation booklet and/or the labels under the hob.

Only for selected countries: In case of exhaust installation a window switch might be required (consult an authorised technician). You need to buy it separately as it is not supplied with the hob. The window switch must be installed by an authorised technician. Refer to the installation booklet.

If the appliance is installed above a drawer, the hob ventilation can warm up the items stored in the drawer during the cooking process.

Assembling the filtering unit

The appliance must be used at all times with all the filters dedicated to the chosen installation mode. Refer to "Filter selection". Before the first use make sure to insert the filters in the extractor with the handles facing inwards. Then place the grid on the extractor.

3.3 Connection cable

WARNING!

All electrical connections must be made by a qualified electrician.







- For a single phase or two phase connection, use the cable type: H03V2V2-F or H05BB-F which withstands a temperature of 90 °C or higher.
- To replace the damaged mains cable, use the cable: H03V2V2-F or H05BB-F which withstands a temperature of 90 °C or higher.

- The single wire must have a diameter of minimum 1,5 mm².
- Connections via contact plugs, drilling or soldering the wire ends, and connecting the cable without cable end sleeve are forbidden.
- Contact your local Authorised Service Centre. The connection cable may only be replaced by a qualified electrician.

3.4 Power limitation

Power limitation defines how much power is used by the hob in total, within the limits of the house installation fuses. The hob is set to its highest possible power level by default. Make sure that the selected power fits the house installation fuses.

To decrease or increase the power level:

1. Enter the menu: press and hold  for 3 seconds. Then, press and hold .
2. Press  on the front timer until  appears.
3. Press  /  on the front timer to navigate between the settings.
4. Press  to exit.

Power levels:

P73 - 7,350 W, P15 - 1,500 W, P20 - 2,000 W, P25 - 2,500 W, P30 - 3,000 W, P35 - 3,500 W, P40 - 4,000 W, P45 - 4,500 W, P50 - 5,000 W, P60 - 6,000 W

4. PRODUCT DESCRIPTION

4.1 Product overview

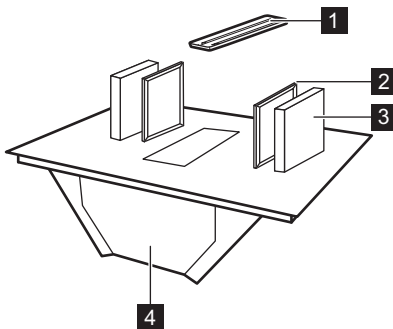

- 1** Grid
- 2** Grease filter
- 3** Carbon filter
- 4** Drip tray
- 5** Hob
- 6** Air duct adapter
- 7** Air duct fitting for the back wall

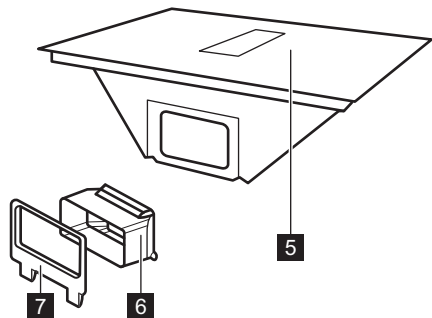



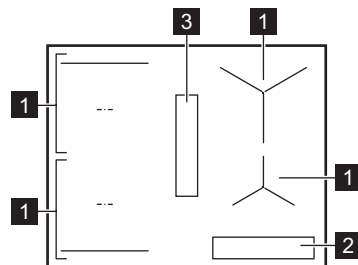





4.2 Cooking surface layout



- 1** Induction cooking zone
- 2** Control panel
- 3** Extractor

4.3 Symbols on the control panel and the display

Symbol / indicator	
	On / Off
	Pause
	Timer
	Bridge
AUTO	Automatic mode of the extractor
	Manual mode of the extractor

Symbol / indicator	
	Boost
P	PowerBoost
	Lock/Child Safety Device
E + digit	There is a malfunction.
	The filter needs to be cleaned or replaced.
	OptiHeat Control

5. BEFORE FIRST USE

5.1 Filter selection

Before the first use make sure to set the correct filter type based on the mode of installation. Refer to "Menu structure".

Recirculation mode: carbon filter (in combination with a grease filter)

Carbon filters, containing active foam, neutralise smoke and cooking smells. You can choose between:

- **OdourClean STANDARD** (white, disposable)
- **OdourClean PLUS** (black, regenerable)

To use the appliance in recirculation mode, contact an authorised technician to adjust the installation. Go to the user settings and switch the carbon filter notification on by selecting CF, and then On. Then choose one of the filters:

- **OdourClean STANDARD:** Select Ft, then 2.

- **OdourClean PLUS:** Select Ft, then 1.

Exhaust mode: grease filter

Grease filters collect grease, oil, and food remains and prevent them from getting into the extractor system.

To use the appliance in exhaust mode, contact an authorised technician to adjust the installation. Then go to the user settings and switch the carbon filter notification off by selecting CF, and then Off.

 Exhaust mode may affect room air pressure and therefore requires proper ventilation to prevent the backflow of combustion gases from other appliances. Ensure that the installation environment complies with the supplied safety guidelines.

6. DAILY USE

6.1 Using the hob

Press and hold  to activate or deactivate the hob. Put the cookware on the cooking zone and set a heat setting using the control bar. To deactivate the cooking zone, press 0.

Eco Timer

To save energy, the cooking zone deactivates shortly before the timer stops.

6.2 Cookware

The base of the cookware should be as thick and flat as possible. Clean and dry it before placing cookware on the hob. Do not slide or rub the cookware on the edges and corners of the glass to avoid chipping or damaging the surface. Do not place hot cookware on the control panel to avoid damage to the electronic parts.

Ensure that the cookware is induction compatible (i.e. a magnet sticks to its base). For optimal heat transfer use cookware with bottom diameter similar to the size of the cooking zone. Cookware with a smaller diameter might heat up slower, while one with a larger diameter might overheat and damage the control panel.

Cookware material

- **correct:** cast iron, steel, enamelled steel, stainless steel, multi-layer bottom (with a correct marking from the manufacturer).
- **incorrect:** aluminium, copper, brass, glass, ceramic, porcelain.

Noises during operation

Noises may vary depending on the cookware material and the current heat setting. They are normal and do not indicate any malfunction.

- cracking noise: cookware is made of different materials (a sandwich construction).
- whistling sound: a high heat setting is activated and the cookware is made of different materials (a sandwich construction).
- humming: a high heat setting is activated.
- clicking: electric switching occurs.
- hissing, buzzing: the cooling fan operates.
- rhythmic sound: cookware is detected.

6.3 Pot detection

This feature indicates the presence of cookware on the hob and deactivates the cooking zones if no cookware is detected within 120 sec.

6.4 Automatic Switch Off

As a safety measure, the hob switches off automatically in certain conditions (e.g. when all cooking zones and the extractor are deactivated, when no heat setting or fan speed is selected after activation, or when cookware boils dry).

6.5 OptiHeat Control (3 step Residual heat indicator)

The indicator signals that a cooking zone is still hot. As long as the indicator is visible, there is a risk of burns from residual heat. The indicator disappears when the cooking zone has cooled down.

6.6 Power management

If the hob reaches the limit of maximum available power, the power of the cooking zones will be automatically reduced in order to protect the fuses of the house installation. For cooking zones that have a reduced power,

the control bar blinks and shows the maximum possible heat settings.







6.7 PowerBoost



To activate the maximum heat setting for a limited time. You can use it to boil water faster.

Press  to activate. Once the time runs out the cooking zone returns to the highest heat setting. To deactivate the function, change the heat setting.

6.8 Timer

To specify how long a cooking zone should operate.

Set a heat setting on the cooking zone and press . Set the time using  / , then confirm with . When the set time runs out, the cooking zone deactivates. To cancel the timer, press , then press  until 00 appears on the display.

You can also use the function as a minute minder when the hob is on but none of the cooking zones operate. Press  and set the time using  / .

6.9 Pause

The function sets all active cooking zones to the lowest heat setting.

When the extractor operates in manual mode, the fan speed is reduced to 1. In automatic mode, the fan speed does not change.

The function does not stop any active timers.

To activate/deactivate, press .



6.10 Lock/Child Safety Device

To lock/unlock the control panel as needed.

To lock the control panel briefly while

cooking: press  once. Press again to unlock.

To prevent accidental operation of the

hob: press and hold  for 3 sec while all the zones are deactivated, then switch off the hob. The function stays active when you deactivate the hob. To deactivate the function, switch on the hob, press and hold  for 3 sec, and switch off the hob.

6.11 Bridge

To connect two side cooking zones so that they operate as one. You can use it to cook

with large cookware (e.g. plancha). Make sure the cookware covers the centres of both cooking zones. If the cookware is placed between the centres of the zones, the function will not be activated.

1. Set the heat setting for one of the zones.
2. Press  to activate.
3. Change the heat setting as needed.

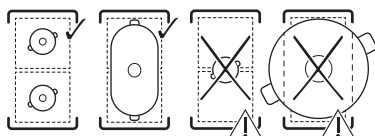

To deactivate the function, press .



6.12 Extractor functions

Manual mode

The extractor can operate when the hob is on or off.

1. Press  to activate the extractor.
2. Adjust the fan speed by pressing  repeatedly.

To deactivate, press  repeatedly until the indicators disappear.

Automatic mode

The extractor adjusts the fan speed based on the temperature of the cooking zone. The automatic mode offers four fan speed options: H1-H4 (low to intense).

1. If the function is not on by default, press AUTO to activate it.
2. Put cookware on a cooking zone and select a heat setting.

To deactivate, press AUTO.

To change the default fan speed (H4), enter the user settings. Refer to "Menu structure".

Boost

The function activates the fan to run at its maximum speed.

Press  to activate the function.

To deactivate, press  again.

The function can operate uninterrupted for a maximum of minutes. After that time the fan speed setting changes to 3.

Auto Breeze

The fan continues running at a minimum speed for 20 minutes after you switch off the hob, then deactivates automatically. The function removes any lingering smells after cooking.

When the function operates, the indicator above AUTO appears.



To stop the function, press AUTO or .





To disable the function completely, enter the user settings. Refer to "Menu structure".

 It is recommended not to disable the function and to let it run uninterrupted for the full cycle.

6.13 Menu structure

Symbol	Setting
b	Sound
P	Power limitation
H	Automatic mode of the fan
dF	Auto Breeze
CF	Carbon filter notification
Ft	OdourClean STANDARD: 2 OdourClean PLUS: 1
E	Alarm/error history

To enter the user settings: press and hold  for 3 sec. Then, press and hold .

Navigating the menu: the menu consists of the setting symbol and a value. To navigate between the settings, press  on the front timer. To change the setting value press  or  on the front timer. **To exit the menu:** press .

6.14 Energy saving tips

- When you heat up water, use only the amount you need.
- Always put lids on the cookware, if possible.
- Use the residual heat to keep food warm or to melt it.
- Set the fan at a low speed level when you start cooking. Once the cooking is finished, keep the fan running for a few minutes.
- Increase the fan speed only to get rid of large amounts of steam or smoke.

- Clean the filter regularly and replace it when necessary to maintain its efficiency.

For more information refer to "Energy efficiency".

7. COOKING GUIDE

The data in the table is for guidance only.

Setting	Use to:	Time (min)
1	Keep cooked food warm. Put a lid on the cookware.	as necessary
1 - 2	Make hollandaise sauce; melt butter, chocolate, gelatine. Mix from time to time.	5 - 25
2	Solidify fluffy omelettes, baked eggs. Cook with a lid on.	10 - 40
2 - 3	Simmer rice and milk-based dishes, heat up ready-made meals. Add at least twice as much liquid as rice, mix milk dishes halfway through.	25 - 50
3 - 4	Stew vegetables, fish, meat. Add a few tablespoons of water. Check the water amount during cooking.	20 - 45
4 - 5	Steam potatoes and other vegetables. Fill the pot with 1-2 cm of water. Check the water level during cooking. Keep the lid on.	20 - 60
4 - 5	Cook larger quantities of food, stews, and soups. Up to 3 l of liquid plus ingredients.	60 - 150
6 - 7	Gently fry escalopes, veal cordon bleu, cutlets, rissoles, sausages, liver, roux, eggs, pancakes, doughnuts. Turn over when needed.	as necessary
7 - 8	Deep-fry hash browns, loin steaks, steaks. Turn over when needed.	5 - 15
9	Boil water, cook pasta, sear meat (goulash, pot roast), deep-fry chips.	
P	Boil large quantities of water. PowerBoost is activated.	

8. CARE AND CLEANING

8.1 Cleaning the hob

- Clean the hob after each use.
- Always use cookware with a clean base.
- Do not let cookware boil dry or reach excessively high temperatures.
- Do not use cookware made of induction-incompatible materials. Such materials may scratch or stain the hob surface.
- Scratches or dark stains on the glass surface do not affect the performance of the hob.
- Do not use knives or any other sharp, metal tools to clean the glass surface.
- Use a recommended scraper only as an additional tool after standard cleaning.
- Wait until the hob cools down and clean the surface with a moist cloth and a non-abrasive detergent. After cleaning, wipe the surface dry with a soft cloth.
- To clean the metal side trim use only a dishwashing detergent with warm water. Then wipe it dry with a cloth.

- Do not use mildly abrasive cleaning milk, polishing detergents, scrapers, or the hard layer of a sponge to clean the side trim.
- The gap between the glass surface and the side trim may collect dirt and small particles of food.
Use a wooden toothpick to clean the gap.
- Do not use any sharp metal tools to clean the gap as they may widen the gap and damage the glass surface or the side trim.
- **Remove immediately:** melted plastic, plastic foil, salt, sugar, and food with sugar. Use a scraper and take care to avoid burns.
- **Remove when the hob is sufficiently cool:** limescale rings, water rings, fat stains, burnt food remains, shiny metallic discolouration. Clean the surface as described above. To remove shiny metallic discolouration use a soft cloth and a solution of water and vinegar.

8.2 Cleaning the extractor

Grid

The grid is made of aluminium. Wash it manually or in a dishwasher and wipe with a soft cloth.

Drip tray

The drip tray located under the extractor collects condensation created during cooking. Remember to empty the tray regularly.

1. Take hold of the underside of the drip tray with both hands and slide it forward. Then move it carefully downwards to avoid spilling the water.

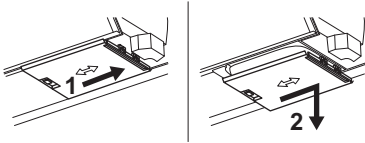

2. Wash the tray manually (using warm water, soap, and a soft cloth/sponge) or in a dishwasher (standard cycle).

If water or other liquids spill inside the extractor system: switch off the extractor, and clean the area carefully with warm water, a moist cloth or sponge and a mild cleaning agent.

8.3 Cleaning the filters

The filtering unit consists of grease filters **A** and carbon filters **B**.

i The appliance must be used at all times with all the filters dedicated to the chosen installation mode. Refer to "Filter selection".

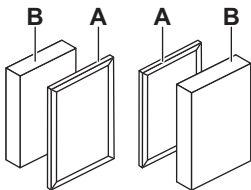

The hob has a built-in counter with a notification that reminds you to clean the respective filters regularly. The notification does not block the use of the hob. The notification stays on for 30 seconds after you deactivate the extractor and the hob.

Grease filter

- After 40 hours of use a static indicator  appears to signal that it is time to clean the grease filters.

OdourClean STANDARD carbon filter

- After 180 hours of use the indicator  starts blinking to signal that it is time to replace the filters.
- Inspect the filters regularly for the level of accumulated grease. Replace them when the blinking indicator appears (approximately once a year, depending on the frequency of use) or sooner, if needed.

OdourClean PLUS carbon filter

- After 140 hours of use the indicator  starts blinking to signal that it is time to regenerate the filters.
- Clean the filters only when the built-up grease is visible.
- Regenerate the filters only when the blinking indicator appears. The maximum number of regeneration cycles is 8. After that time, replace the filters.

Disassembling/reassembling the filters

1. Remove the grid.
2. Take out the filters by grabbing the handles.

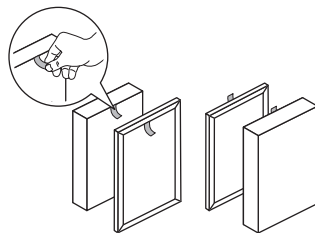



3. Reassemble the filtering unit after cleaning. Insert the filters in the extractor with the handles facing inwards. Then place the grid on the extractor.

Cleaning the grease filters

1. Clean the filters as soon as the built-up grease is visible. Wash the grease filters carefully in warm water using a mild cleaning agent, then rinse with warm water. You can use a soft sponge, a soft cloth, or a non-abrasive cleaning brush to remove food remains. You can wash them in the dishwasher on a standard cycle with other dishes in the same load. Some mild discolouration of the mesh

may naturally occur, which does not affect the performance of the filter.

2. Leave the filters for some time to dry at room temperature.
3. Put the filters back inside. If the notification  is on, press  briefly to restart the counter.

Cleaning the OdourClean PLUS carbon filters

1. Wash the filters carefully in warm water without any cleaning agents. You can use a soft sponge, a soft cloth, or a non-abrasive cleaning brush to remove food remains. You can also wash the filters in a dishwasher at 65-70 °C (using a program longer than 90 min), without

detergents and without dishes in the same load.

2. Leave the filters to dry for at least 24h at room temperature.
3. Reassemble the filtering unit and put it back inside.

Regenerating the OdourClean PLUS carbon filters

1. Clean the filters first, as described above.
2. Put the filters in the oven set to 100 °C for 120 min, placing them on the middle wire shelf. Use a non-fan oven function.
3. Reassemble the filtering unit and put it back inside. Press  briefly to reset the counter.

9. TROUBLESHOOTING

 If you cannot find a solution to the problem below, contact an Authorised Service Centre.

You cannot activate/operate the hob.

- Make sure the hob is correctly connected to the electrical supply.
- Make sure that the fuse is the cause of the malfunction. If the fuse blows repeatedly or if you can hear a constant beep noise, contact a qualified electrician to inspect the installation.
- Make sure the control panel is clean and unobstructed by cookware/foreign objects.

The hob switches off by itself after some time.

- This is not a malfunction. In certain situations the hob switches off automatically to maintain safety. Refer to "Automatic Switch Off".

The maximum heat setting for one of the cooking zones is not available or it keeps changing between two levels.

- This is not a malfunction. Refer to "Power management".

- Reduce the heat setting of the other cooking zones connected to the same phase.

The extractor fan does not run/deactivates by itself.

- Switch the hob off and unplug it from the main supply. Let the appliance cool down, then plug it in again.
- Make sure the room is sufficiently ventilated. You may need to install the window switch. Contact an Authorised Service Centre.

appears.

- Clean/replace the filter. Refer to "Care and cleaning".

and a digit appear.

- Switch off the hob, wait a few minutes, then switch it back on. If the problem continues, contact an Authorised Service Centre.

The control panel blinks.

- Use cookware with bottom diameter similar to the size of the cooking zone.
- Make sure the cookware is induction-compatible.

10. TECHNICAL DATA

10.1 Rating plate

Model NCH74B01AB
Typ 67 B4A 01 AA

PNC 949 598 096 02
220 - 240 V / 400 V 2N, 50 Hz

Induction
 Serial number
 AEG

Made in: Germany
 7.35 kW

10.2 Cooking zones specification

The power of the cooking zones might slightly differ from the data below, depending on the material and the dimensions of the cookware.

Cooking zone	Nominal power (maximum heat setting) [W]	PowerBoost [W]	PowerBoost maximum duration [min]	Cookware diameter [mm]
Left front	2300	3200	10	125 - 210
Left rear	2300	3200	10	125 - 210
Right front	1400	2500	4	125 - 145
Right rear	1800	2800	10	145 - 180

11. ENERGY EFFICIENCY

11.1 Product Information according to (EU) No 66/2014

The energy measurements referring to the cooking area are identified by the markings of the respective cooking zones.

Model identification	NCH74B01AB	
Type of hob	Built-In Hob	
Number of cooking zones	4	
Heating technology	Induction	
Diameter of circular cooking zones (Ø)	Left front	21.0 cm
	Left rear	21.0 cm
	Right front	14.5 cm
	Right rear	18.0 cm
Energy consumption per cooking zone (EC electric cooking)	Left front	189.1 Wh/kg
	Left rear	189.1 Wh/kg
	Right front	180.2 Wh/kg
	Right rear	178.3 Wh/kg
Energy consumption of the hob (EC electric hob)	184.2 Wh/kg	

Appliance tested according to: EN IEC 60350-2.

11.2 Information requirements according to (EU) No 2023/826

Power consumption in off mode	0.3 W
Maximum time needed for the equipment to automatically reach the applicable low power mode	2 min

Appliance tested according to: EN 50564.

11.3 Product Information Sheet and Product Information according to (EU) No 65/2014 and (EU) No 66/2014

Product Information Sheet

Supplier's name or trade mark	AEG	
Model identifier	NCH74B01AB	
Annual Energy Consumption - AEEhood	27.6	kWh/a
Energy Efficiency Class	A+	
Fluid Dynamic Efficiency - FDEhood	32.6	
Fluid Dynamic Efficiency class	A	
Lighting Efficiency - LEhood	-	lux/W
Lighting Efficiency Class	-	
Grease Filtering Efficiency - GFEhood	85.1	%
Grease Filtering Efficiency class	B	
Minimum Air Flow in normal use	250.0	m ³ /h
Maximum Air Flow in normal use	520.0	m ³ /h
Air Flow at intensive/boost setting	630.0	m ³ /h
A-weighted Sound Power Emissions at minimum speed	50	db(A) re 1 pW
A-weighted Sound Power Emissions at maximum speed	66	db(A) re 1 pW
A-weighted Sound Power Emissions at intensive or boost speed	69	db(A) re 1 pW
Measured power consumption off mode - P _o	0.49	W
Measured power consumption in standby mode - P _s	-	W

Additional Information

Time increase factor - f	0.8	
Energy Efficiency Index - EEIhood	41.0	
Measured air flow rate at best efficiency point - QBEP	276.4	m ³ /h
Measured air pressure at best efficiency point - PBEP	402	Pa
Maximum air flow - Q _{max}	630.0	m ³ /h
Measured electric power input at best efficiency point - WBEP	94.6	W
Nominal power of the lighting system - WL	-	W
Average illumination of the lighting system on the cooking surface - E _{middle}	-	lux

Appliance tested according to: EN IEC 61591, EN IEC 60704-1, EN IEC 60704-2-13, EN 50564.

12. ENVIRONMENTAL CONCERNS

Recycle materials with the symbol . Put the packaging in relevant containers to recycle it. Help protect the environment and human health by recycling waste of electrical and electronic appliances. Do not dispose of ap-

pliances marked with the symbol  with the household waste. Return the product to your local recycling facility or contact your municipal office.



701137181-B-152026