

# AEG

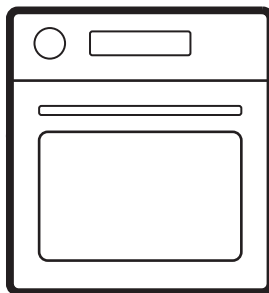

[aeg.com/register](http://aeg.com/register)



BSX23101XM

# INSTALLATION

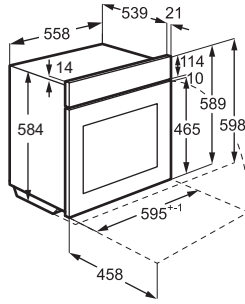
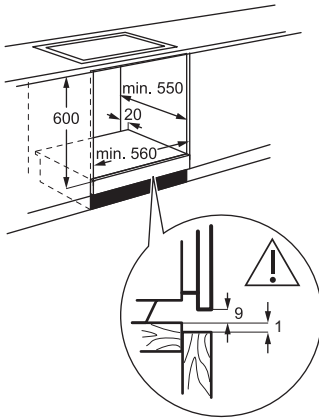

(\*mm)

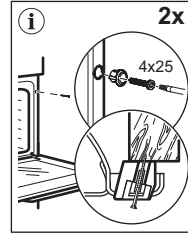

[www.youtube.com/electrolux](http://www.youtube.com/electrolux)  
[www.youtube.com/aeg](http://www.youtube.com/aeg)

How to install your AEG/Electrolux  
 Oven with Hob - Built Under installation

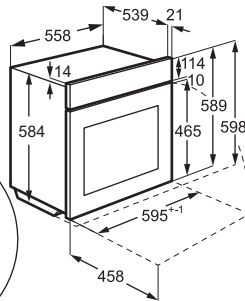
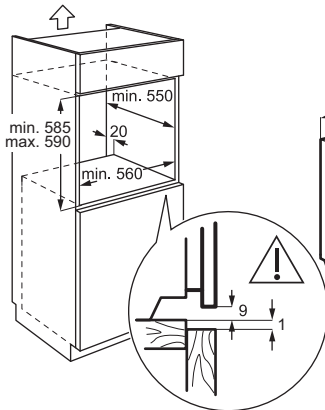
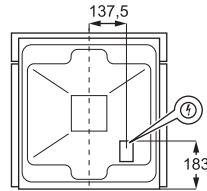
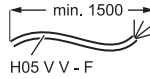

(\*mm)

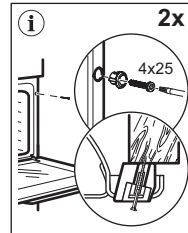

[www.youtube.com/electrolux](http://www.youtube.com/electrolux)  
[www.youtube.com/aeg](http://www.youtube.com/aeg)

How to install your AEG/Electrolux  
 Oven - Column installation

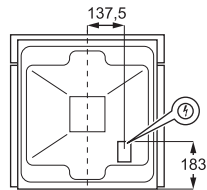
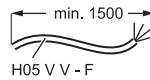

1. SAFETY INFORMATION.....	3
2. SAFETY INSTRUCTIONS.....	4
3. PRODUCT DESCRIPTION.....	7
4. BEFORE FIRST USE.....	7
5. DAILY USE.....	8

6. HINTS AND TIPS.....	9
7. CARE AND CLEANING.....	10
8. TROUBLESHOOTING.....	12
9. ENERGY EFFICIENCY.....	12
10. ENVIRONMENTAL CONCERNS.....	13

## 1. SAFETY INFORMATION

Before the installation and use of the appliance read the supplied instructions carefully. The manufacturer is not responsible for any injuries or damage that result from incorrect installation or usage. Always keep the instructions in a safe and accessible location for future reference.

### 1.1 Children and vulnerable people safety

- This appliance can be used by children aged from 8 years and above and persons with reduced physical, sensory or mental capabilities or lack of experience and knowledge if they have been given supervision or instruction concerning the use of the appliance in a safe way and understand the hazards involved. Children of less than 8 years of age and persons with very extensive and complex disabili-

- ties shall be kept away from the appliance unless continuously supervised.
- Children should be supervised to ensure that they do not play with the appliance.
- Keep packaging away from children and dispose of it properly.
- **WARNING:** The appliance and its accessible parts become hot during use. Keep children and pets away during use and cooling.
- Activate the child safety device, if available.
- Children must not clean or maintain the appliance without supervision.

### 1.2 General Safety

- This appliance is for cooking purposes only.
- This appliance is designed for single household domestic use in an indoor environment.
- This appliance may be used in offices, hotel guest

rooms, bed & breakfast guest rooms, farm guest houses, and other similar accommodation where such use does not exceed average domestic usage levels.

- Do not use the appliance before installing it in the built-in structure.
- Disconnect the appliance from the power supply before carrying out any maintenance.
- If the supply cord is damaged, it must be replaced by the manufacturer, its authorised service centre or similarly qualified persons to avoid an electrical hazard.
- **WARNING:** Ensure that the appliance is switched off before replacing the lamp to avoid the possibility of electric shock.

- **WARNING:** The appliance and its accessible parts become hot during use. Care should be taken to avoid touching heating elements or the surface of the appliance cavity.
- Always use oven gloves to remove or insert accessories or ovenware.
- To remove the shelf supports first pull the front of the shelf support and then the rear end away from the side walls. Install the shelf supports in the opposite sequence.
- Do not use a steam cleaner to clean the appliance.
- Do not use harsh abrasive cleaners or sharp metal scrapers to clean the glass door since they can scratch the surface, which may result in shattering of the glass.

## 2. SAFETY INSTRUCTIONS

### 2.1 Installation

#### **WARNING!**

Only a qualified person must install this appliance.

- Remove all the packaging.
- Do not install or use a damaged appliance.
- Follow the installation instructions available on our website.

- Be careful when moving the appliance, as it is heavy. Use safety gloves and enclosed footwear.
- Do not pull the appliance by the handle.
- Install the appliance in a safe and suitable location that meets installation requirements.
- Keep the minimum distance from other appliances and units.
- Before mounting the appliance, ensure it is level and that the door opens without any restraint.

- The appliance is equipped with an electric cooling system. It must be operated with the electric power supply.

## 2.2 Electrical connection

### **WARNING!**

Risk of fire and electric shock.

- All electrical connections should be made by a qualified electrician.
- Make sure the parameters on the rating plate are compatible with the electrical ratings of the mains power supply.
- The appliance must be earthed. Always use a correctly installed shockproof socket.
- Do not use multi-plug adapters and extension cables.
- Avoid damaging the mains plug and cable. If replacement is needed, it must be done by our Authorized Service Centre.
- Do not let mains cables touch or come near the appliance door or the niche below, especially when it operates or the door is hot.
- Shock protection of live and insulated parts must be fastened securely and should not be removable without tools.
- Connect the mains plug to the socket only at the end of installation. Ensure access to the mains plug after installation.
- If the mains socket is loose, do not connect the mains plug.
- Do not disconnect the appliance by pulling on the mains cable. Always pull on the mains plug.
- Use only correct isolation devices: line protecting cut-outs, fuses (screw type fuses removed from the holder), earth leakage trips and contactors.
- The electrical installation must have an isolation device that disconnects the appliance from the mains at all poles, with a contact opening width of at least 3 mm.
- This appliance is supplied with a main plug and a main cable.

### **Cable types applicable for installation or replacement for Europe:**

H07 RN-F, H05 RN-F, H05 RRF, H05 VV-F, H05 V2V2-F (T90), H05 BB-F

For the section of the cable refer to the total power on the rating plate. You can also refer to the table:

Total power (W)	Section of the cable (mm <sup>2</sup> )
maximum 1,380	3x0.75
maximum 2,300	3x1
maximum 3,680	3x1.5

The earth cord (green / yellow cable) must be 2 cm longer than the brown phase and blue neutral cables.

## 2.3 Use

### **WARNING!**

Risk of injury, burns and electric shock or explosion.

- Do not change the specification of the appliance.
- Ensure ventilation openings are not blocked.
- Do not let the appliance stay unattended during operation.
- Deactivate the appliance after each use.
- Be careful when opening the appliance door during operation, as hot air and flammable mixtures from alcohol ingredients can be released.
- Do not operate the appliance with wet hands or when it comes in contact with water.
- Do not apply pressure on the open door.
- Do not use the appliance as a work surface or as a storage surface.
- Keep sparks and open flames away from the appliance when the door is open.
- Use only approved glass and jars for preserving.
- Do not place flammable products near the appliance.

### **WARNING!**

Risk of damage to the appliance.

- To prevent damage or discoloration to the enamel:
  - do not place ovenware or objects directly on the cavity bottom.
  - do not place aluminum foil directly on the cavity bottom.
  - do not put water directly into the hot appliance.
  - do not leave moist dishes and food in the appliance after cooking.
  - be careful when removing or installing accessories.

- Enamel or stainless steel discoloration does not affect performance of the appliance.
- Use a deep pan for moist cakes, as fruit juices can cause permanent stains.
- Always cook with the appliance door closed.
- If the appliance is installed behind a furniture panel, do not close the panel during use or until the appliance is fully cooled to prevent heat and moisture damage.
- Concerning the lamp(s) inside this product and spare part lamps sold separately: These lamps are intended to withstand extreme physical conditions in household appliances, such as temperature, vibration, humidity, or are intended to signal information about the operational status of the appliance. They are not intended to be used in other applications and are not suitable for household room illumination.
- This product contains a light source of energy efficiency class G.
- Use only lamps with the same specifications.
- To repair the appliance contact the Authorised Service Centre. Use original spare parts only.

## 2.4 Care and cleaning

### **WARNING!**

Risk of injury, fire, or damage to the appliance.

- Before maintenance, deactivate the appliance and unplug it from the mains.
- Ensure the appliance is cold to avoid glass breakage. If the door glass panels are damaged, contact the authorized service centre for replacement.
- Be careful when you remove the door from the appliance, it is heavy.
- Clean and dry the appliance, its cavity, and accessories after each use to prevent steam condensation, corrosion, and surface deterioration.
- Use a microfibre cloth, warm water, and neutral detergents for cleaning the appliance and accessories. Do not use abrasive products, pads, solvents, sharp-edged or metal objects.
- Follow safety instructions on packaging when using an oven spray.

## 2.5 Disposal

### **WARNING!**

Risk of injury or suffocation.

- Contact your municipal authority for information on how to dispose of the appliance.
- Disconnect the appliance from the mains, then cut off and dispose of the electrical cable.

## 3. PRODUCT DESCRIPTION

### 3.1 General overview

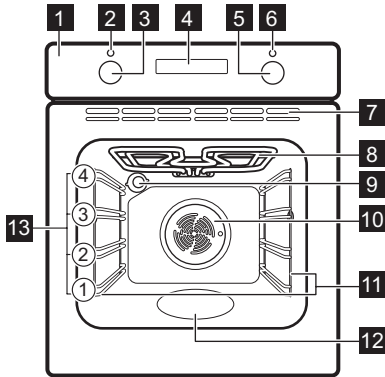

- 1 Control panel
- 2 Power lamp / symbol
- 3 Knob for the heating functions
- 4 Display
- 5 Control knob (for the temperature)
- 6 Temperature indicator / symbol
- 7 Air vents for the cooling fan
- 8 Heating element
- 9 Lamp
- 10 Fan
- 11 Shelf support, removable
- 12 Cavity embossment - Aqua cleaning container
- 13

- 13 Shelf positions

### 3.2 Control panel

—, + To set the time.

⌚ To set a clock function.

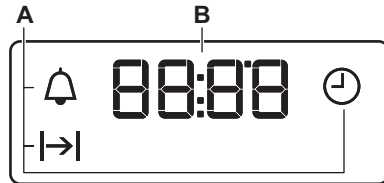

- A. Clock functions
- B. Timer
- C. Heat-up indicator (selected models only)

#### To turn on the appliance:

1. Press the knobs. The knobs come out (selected models only).
2. Turn the knob for the heating functions to select a function.
3. Turn the control knob to adjust settings.

To turn off the appliance: turn the knob for the heating functions to the off position **0**.

## 4. BEFORE FIRST USE

### 4.1 Setting the time

After the first connection to the mains, wait until the display shows: "**00:00**" or "**12:00**" (depending on the model).

1. +, — - press to set the time.
2. ⌚ - press to confirm it or the set time of day will be saved automatically after 5 seconds.









### 4.2 Initial preheating and cleaning

1. Preheat the empty appliance to remove any odours. Ventilate the room.

2. Remove all accessories and shelf supports.
3. Set each function to maximum temperature and let the appliance operate for specified durations: □ 1 h, □ 15 min, ☑ 15 min. Refer to Daily use.
4. Turn off the appliance and let it cool down.
5. Clean with a microfiber cloth, warm water, and mild detergent. Replace accessories and shelf supports.

## 5. DAILY USE

### 5.1 Heating functions

	<b>Light:</b> Oven lamp
	<b>Fan Cooking:</b> Tenderness, crispiness
	<b>Moist Fan Baking:</b> Baking
	<b>Conventional Cooking / Aqua Clean:</b> Traditional baking, crispiness, crust gloss / Cleaning
	<b>Bottom Heat:</b> Preserving food
	<b>True Fan Cooking:</b> Even baking, tenderness, drying
	<b>Grill:</b> Toasting, grilling
	<b>Turbo Grilling:</b> Roasting meat, making gratin, browning
	<b>Defrost:</b> Defrosting

### 5.2 Setting a heating function

1. Turn the knob for the heating functions to select a heating function.
2. Turn the control knob to select the temperature.
3. When the cooking ends, turn the knobs to the off position to turn off the appliance.



### 5.3 Timer



1. Press  repeatedly to select a clock function:

 **Time of Day:** Set, change, or check the time of day.

 **Duration:** Set operating time. Available after setting a heating function and temperature. The appliance turns off automatically when the set time ends.

 **Minute Minder:** Set a countdown.

2.  ,  - press to set the time.
3. When the set time ends, a signal sounds. Press any button.
4. Turn the knobs to the off position, if needed.

To cancel a clock function, press  repeatedly until its symbol flashes. Press and hold  until the display shows **00:00**.

### 5.4 Accessories



Accessories available depending on model. Scan the QR code to check how to use accessories supplied with your appliance. You can order optional accessories separately. For more information, please contact your local supplier.

A small indentation at the top increases safety and provides tilt protection. The rim around the shelf prevents cookware from slipping off the shelf.

Insert the accessory (wire shelf / tray) between the guide bars of the shelf support. Make sure that the shelf touches the back of the oven interior and the feet point down.

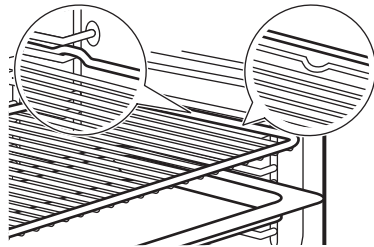

If your tray has a slope, position it towards the back of the oven interior.

If there is an inscription on the accessory, make sure it is facing you.

If you are using a tray with holes, place the tray / pan underneath to collect dripping liquids.

### 5.5 Trivet and Grill- / Roasting pan

#### **WARNING!**

Be careful when you remove the accessories from a hot appliance. There is a risk of burns.

You can use the trivet to roast larger pieces of meat or poultry on one shelf position.

1. Put the trivet into the deep pan so that the supports of the wire shelf point up.

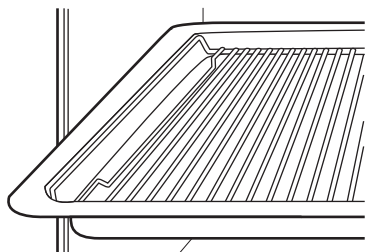

- Put the deep pan into the appliance on the necessary shelf position.

You can use the trivet to grill flat dishes in large quantities and to toast.

- Put the trivet into the deep pan so that the supports of the wire shelf point down.

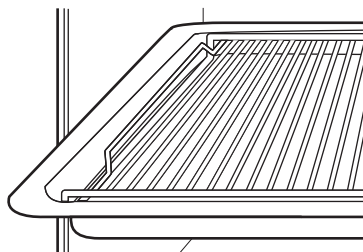

- Put the deep pan into the appliance on the necessary shelf position.

## 6. HINTS AND TIPS

### 6.1 Cooking recommendations

The temperature and cooking times in the tables are for guidance only. They depend on the recipes, quality and quantity of the ingredients used. If you cannot find the settings for a specific recipe, look for a similar one.

Count the shelf positions from the bottom of the oven floor.

#### Symbols used in the tables:





	Food type
	Heating function
$^{\circ}\text{C}$	Temperature
	Shelf position
	Cooking time (min)
	Additional information

### 6.2 Moist Fan Baking

For the best results follow suggestions listed in the table below.

	$^{\circ}\text{C}$			
Sweet rolls, 12 pieces	180	2	35 - 40	1)
Rolls, 9 pieces	180	2	35 - 40	1)
Pizza, frozen, 0.35 kg	220	2	35 - 40	2)
Swiss roll	170	2	30 - 40	1)
Brownie	180	2	30 - 40	1)







	$^{\circ}\text{C}$			
Soufflè, 6 pieces	200	3	30 - 40	3)
Sponge flan base	170	2	20 - 30	4)
Victoria sandwich	170	2	35 - 45	5)
Poached fish, 0.3 kg	180	3	35 - 45	1)
Whole fish, 0.2 kg	180	3	35 - 45	1)
Fish fillet, 0.3 kg	180	3	35 - 45	6)
Poached meat, 0.25 kg	200	3	40 - 50	1)
Shashlik, 0.5 kg	200	3	25 - 35	1)
Cookies, 16 pieces	180	2	20 - 30	1)
Macaroons, 20 pieces	180	2	40 - 45	1)
Muffins, 12 pieces	170	2	30 - 40	1)
Savory pastry, 16 pieces	170	2	35 - 45	1)
Short crust biscuits, 20 pieces	150	2	40 - 50	1)
Tartlets, 8 pieces	170	2	20 - 30	1)
Vegetables, poached, 0.4 kg	180	3	35 - 40	1)





	°C			
Vegetarian omelette	200	3	30 - 45	6)
Mediterranean vegetables, 0.7 kg	180	4	35 - 40	1)



- 1) Use baking tray or dripping pan.
- 2) Use wire shelf.
- 3) Use ceramic ramekins on wire shelf.
- 4) Use flan base tin on wire shelf.
- 5) Use baking dish on wire shelf.
- 6) Use pizza pan on wire shelf.



### 6.3 Information for test institutes



Tests according to IEC 60350-1.

		°C		
Small cakes, 16 per tray				
	3	170	20 - 35	1)
	3	160	20 - 35	1)
	1 and 3	160	20 - 35	1)

		°C		
Apple pie, 2 tins Ø20 cm				

	1	170	70 - 90	2)
	2	160	70 - 90	2)

Sponge cake, cake mould Ø26 cm				
	2	170	35 - 45	2)
	2	160	35 - 45	2)

Short bread				
	3	150	20 - 35	1) 3)
	3	150	20 - 35	1) 3)

Toast				
	3	max.	1 - 5	2) 3)

- 1) Use Baking tray.
- 2) Use Wire shelf.
- 3) Preheat the appliance for 10 minutes.

## 7. CARE AND CLEANING

### 7.1 Notes on cleaning

- Use a cleaning solution for metal surfaces.
- Clean and check the door gasket around the frame of the cavity.
- Moisture can condense in the appliance or on the door glass panels. To decrease the condensation, let the appliance work for 10 minutes before cooking. Do not store food in the appliance for longer than 20 minutes.
- Do not clean the accessories in a dishwasher.

### 7.2 Removing the shelf supports

1. Make sure the appliance is cold.
2. Pull the front of the shelf support away from the side wall.
3. Pull the rear end of the shelf support away from the side wall and remove it.
4. Put the shelf supports back to the initial position. Repeat the steps in the reverse order.

If the telescopic runners are supplied, its retaining pins must point to the front.

### 7.3 Aqua Clean

This cleaning procedure uses humidity to remove remaining fat and food particles from the appliance.

1. Pour water into the cavity embossment: 150 ml.
2. Set the function .
3. Set the temperature to 90 °C.
4. Let the appliance work for 30 min.
5. Turn off the appliance.
6. Wait until the appliance is cold. Dry the cavity with a soft cloth.

### 7.4 Removing and installing door

The oven door has two glass panels. You can remove the oven door and the internal glass panel to clean it. Read the whole "Removing and installing door" instruction before you remove the glass panels.

#### CAUTION!

Do not use the appliance without the glass panels.

1. Open the door fully and hold both hinges.

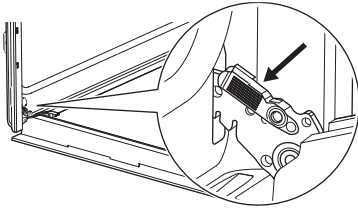

2. Lift and pull the latches until they click.

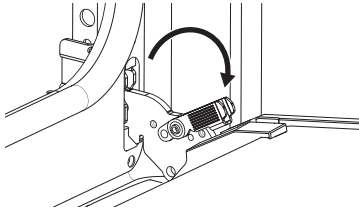

3. Close the oven door halfway to the first opening position. Then lift and pull to remove the door from its seat.

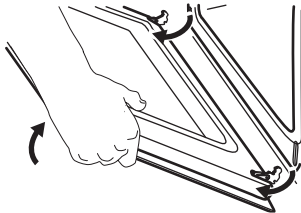

4. Put the door on a soft cloth on a stable surface and release the locking system to remove the internal glass panel.

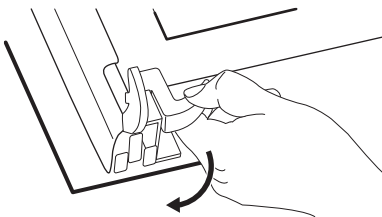

5. Turn the fasteners by 90° and remove them from their seats.

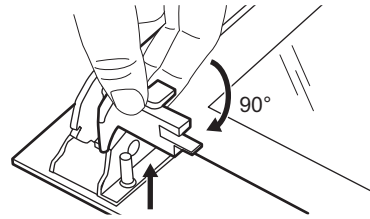

6. First lift carefully and then remove the glass panel.

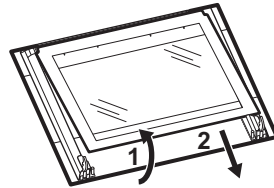

7. Clean the glass panels with water and soap. Dry the glass panels carefully. Do not clean the glass panels in the dishwasher.

8. After cleaning, install the glass panel and the oven door.

If the door is installed correctly, you will hear a click when closing the latches.

When installed correctly, the door trim clicks.

Make sure that you install the internal glass panel **A** in the seats correctly.



## 7.5 Replacing the lamp

Disconnect the appliance from the mains and wait until it is cold.

Replace the lamp with a suitable 300 °C heat-resistant lamp.

### Back lamp

1. Turn the glass cover to remove it.
2. Clean the glass cover.
3. Replace the lamp.
4. Install the glass cover.

## 8. TROUBLESHOOTING

If you cannot find a solution to the problem yourself, contact your dealer or an Authorised Service Centre. Service details are on the rating plate, located on the front frame. It is visible when you open the door. Do not remove the rating plate.

**The door gasket is damaged.** - Do not use the appliance. Contact an Authorised Service Centre.

**The lamp does not work.** - The lamp is burnt out. Replace the lamp.

**The display shows "00:00" or "12:00".** - There was a power cut. Set the time of day.

## 9. ENERGY EFFICIENCY

### 9.1 Product Information Sheet and Product Information according to (EU) No 65/2014 and (EU) No 66/2014

Supplier's name	AEG
Model identification	BSX23101XM 944068451
Energy Efficiency Index	95.1
Energy efficiency class	A
Energy consumption with a standard load, conventional mode	0.89 kWh/cycle
Energy consumption with a standard load, fan-forced mode	0.78 kWh/cycle
Number of cavities	1
Heat source	Electricity
Volume	65 l
Type of oven	Built-In Oven
Mass	29.0 kg

Appliance tested according to: EN IEC 60350-1.

### 9.2 Information requirements according to (EU) No 2023/826

Power consumption in standby	0.8 W
Maximum time needed for the equipment to automatically reach the applicable low power mode	20 min

Appliance tested according to: EN 50564.

### 9.3 Energy saving tips

- Keep the door closed during cooking and avoid opening it often.
- Keep the door gasket clean and make sure it is well fixed in its position.
- Use metal or dark, non-reflective cookware.
- Skip preheating unless needed.
- Minimize breaks between baking multiple dishes.
- When possible, use the cooking functions with fan to save energy (selected models only).
- Use residual heat to keep food warm. Reduce the appliance temperature to minimum 3 - 10 min before the end of cooking.
- Turn off the lamp during cooking unless needed.
- Moist Fan Baking (selected models only) - this function was used to comply with the energy efficiency class and ecodesign requirements (according to EU 65/2014 and EU 66/2014). Tests according to: IEC/EN 60350-1. The oven door should be closed during cooking so that the function is not interrupted and the oven operates with the highest energy efficiency possible. When you use this function the lamp automatically turns off. In some models it takes 30 sec.
- Automatic switch-off - for safety reasons, if the heating function is active and no settings are changed, the appliance will turn off automatically after a certain period of time. If you intend to run a heating function for a duration exceeding the automatic switch-off time, set the cooking time.
  - 12.5 h: 30-115 °C

- 8.5 h: 120-195 °C
- 5.5 h: 200-245 °C

- 3 h: 250-maximum °C

## 10. ENVIRONMENTAL CONCERNS

Recycle materials with the symbol . Put the packaging in relevant containers to recycle it. Help protect the environment and human health by recycling waste of electrical and electronic appliances. Do not dispose of ap-

pliances marked with the symbol  with the household waste. Return the product to your local recycling facility or contact your municipal office.





